

LTM 1080NX

リープヘル製
オールテレーンクレーン
吊上荷重80ton

Technical Data

メインブーム
50m

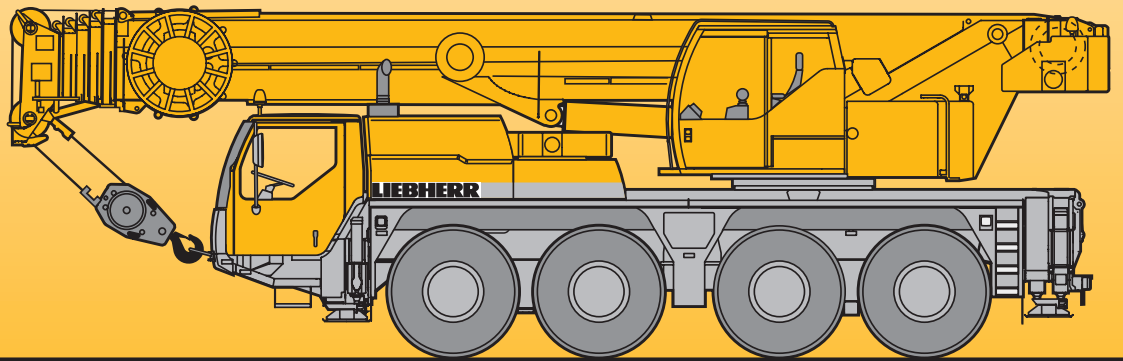

LIEBHERR

クレーン部主仕様

吊上荷重	荷重	80ton
	半径	2.5m
メインブーム	最小長さ	11m
	最大長さ	50m
補助ジブ	油圧チルトジブ	9.5m, 16m
メインブーム伸縮段数		6段
カウンターウェイト (最大)		14.5ton
主巻ウインチ	ラインプルカ	5.7ton
	巻上速度	0-125m/min
補巻ウインチ	ラインプルカ	5.7ton
	巻上速度	0-125m/min
最大地上揚程	メインブーム	49m
	補助ジブ	65m
旋回速度		0-1.5rpm
起伏速度 (83度まで)		約55秒
ブーム伸長速度 (11 ~ 50m)		約310秒
主巻ロープ	ロープ径	17mm
	ロープ長さ	200m
補巻ロープ	ロープ径	17mm
	ロープ長さ	200m

フック仕様

容量 (ton)	シーブ数
80	7
58.4	5
38.3	3
16	1
5.7	-

フックはオプション設定
です。表の中からお選
びください。

特徴

■ コントロール

ジョイスティックタイプの操作レバー (自動復帰式のユニバーサルコントロール)により電気式パイロットコントロールされます。

■ 油圧駆動装置

ウインチ回路には圧力補償付流量調整弁を有し、また、自動出力調整装置付油圧ポンプにより駆動されます。

■ 安全装置および指示計

LICCON II (リーコン II) 過負荷防止計が装備され、吊上げ総荷重、作業半径、ブーム長さ、揚程、アウトリガー反力などがデジタルで表示されます。

過巻防止装置、ドラム回転計、過巻出し防止装置、油圧安全弁、油圧システム保護用安全バルブが装備されています。

クレーン部キャabinを20度までチルトする事ができます。

カウンターウェイト

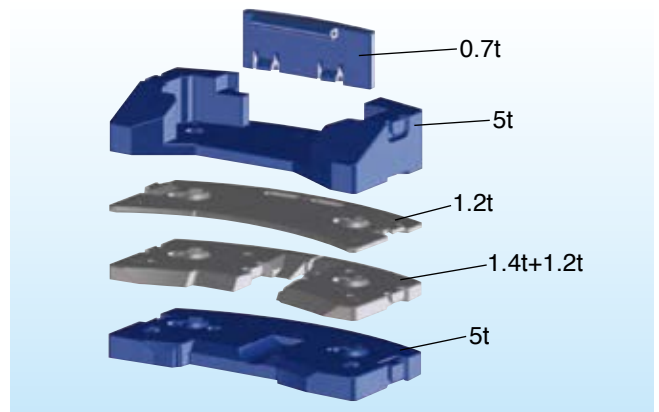

走行軌跡図

通常走行時

単位: mm

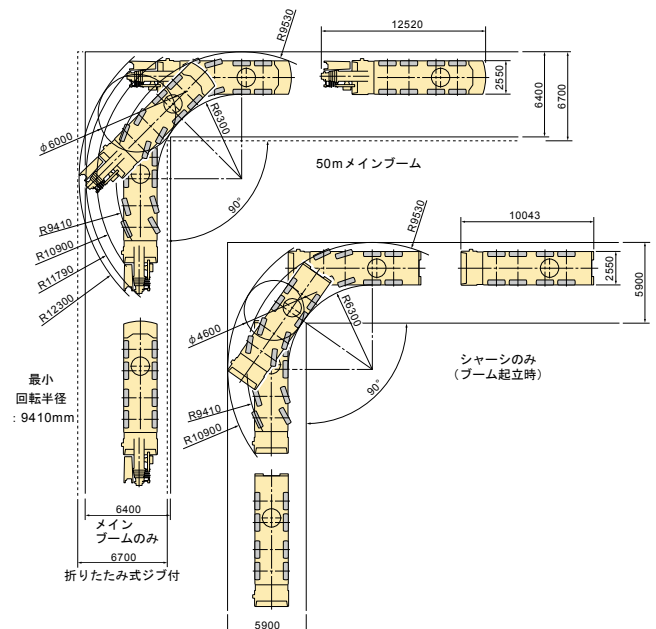

キャリア部主仕様

軸数	4
最高速度	75km/h
総輪数	8
定員	2名
タイヤ	14.00 R25
登坂能力※(低速切替時)	約31.6°
最小回転半径	9.41m/6.56m

※登坂時の路面状況により、能力も多少異なります。

エンジン仕様

メーカー名	リープヘル社製
型式	D936L-A6 ディーゼル・エンジン
冷却方式	水冷
シリンダー数	6
出力	367HP/2000rpm
最大トルク	1700N・m/1000-1500rpm
燃料タンク	約410L

特徴

■ トランスミッション

ZF製ミッションで "AS-TRONIC" 自動制御システムを採用しています。

前進12段、後進2段となっております。

■ 車軸

悪路においては、デフロックすることが可能です。また、第1軸を追加駆動することができます。(オプション設定)

■ サスペンション

全軸ハイドロニューマチックサスペンションであり、自動水平復帰機能(ニポー)を有しています。

状況に応じて車高を上下に調整可能です。(±100mm)

全軸油圧サスペンションをロックすることが可能です。

■ ステアリング

全ての軸が操舵されます。油圧源として1つは通常時、エンジンで駆動され、もう1つは非常用として駆動軸により駆動されます。

■ 常用ブレーキ

2回路式サーボブレーキが全軸に装備されています。

全軸ディスクブレーキを装備しています。

また、エディカレント式電磁ブレーキ(テルマブレーキ)を装備しています。

■ パーキング用ブレーキ

スプリング作動のブレーキが第1軸、第2軸および4軸に作動します。

走行速度

	1	2	3	4	5	6	7	8	9	10	11	12	R1	R2	
km/h	2.18-5.80	7.5	9.6	12.4	15.7	20.2	26.5	34.1	44	56.4	71.7	75	2.35-6.20	8.1	38.9%
	0.53-1.40	1.8	2.3	3	-	-	-	-	-	-	-	-	0.57-1.50	2	60%

走行軌跡図

リアステアリング走行時

単位：mm

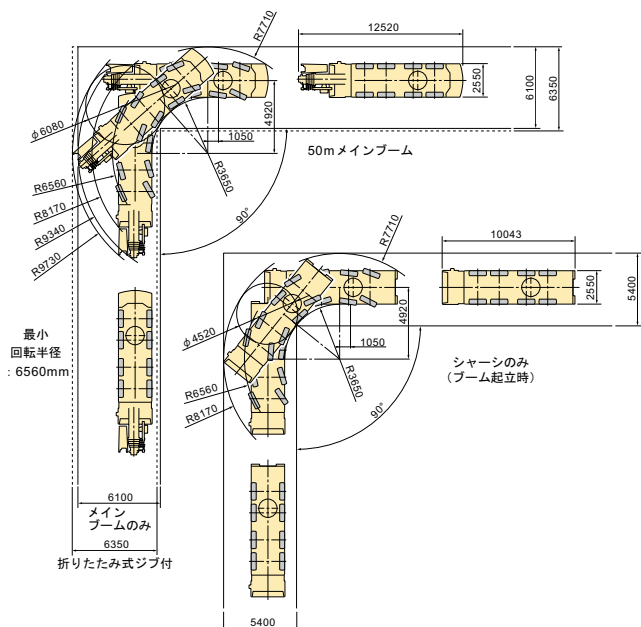

駆動部

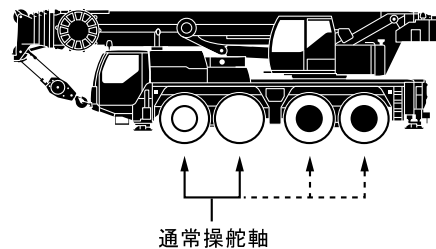

●：常時駆動します。(公道走行時)

○：追加駆動します。(オプション)

現場構内、低速走行時は第1～4軸が操舵され、第3、4軸は独立してリアステアリング操作可能、通常公道走行時、3軸は固定され約30km以上で4軸が直進に固定

本機は、公道を走行する場合、カウンターウェイトをはずし、走行しなければなりません。

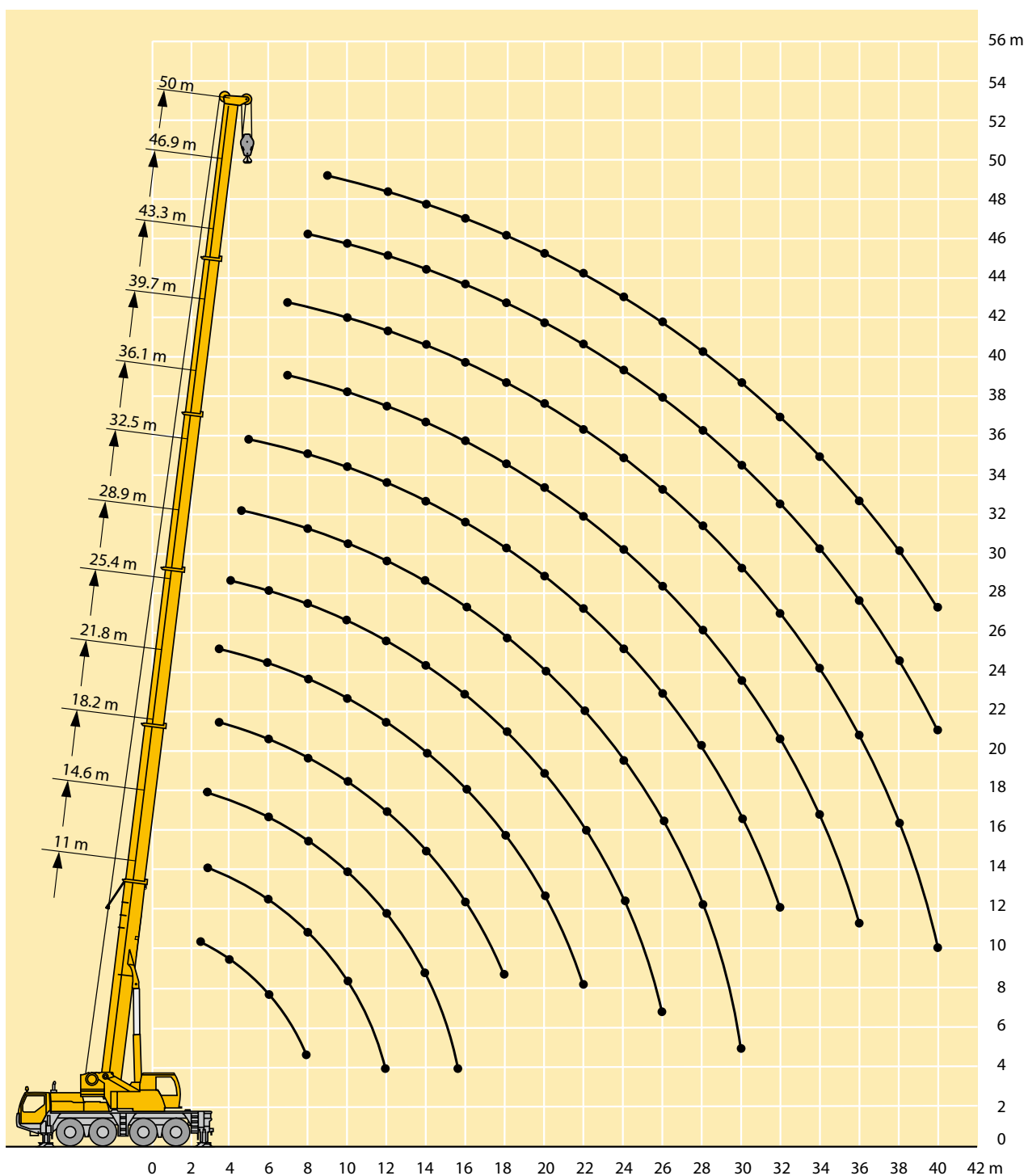

注意

- 1 定格総荷重はフックブロック、玉掛ワイヤー等の自重を含みます。
また、下記の条件が考慮されていないのでクレーンの操作には充分気をつけてください。
 - ① 地盤の強度、地震による影響
 - ② 作業速度に応じた動荷重および台風または強風による影響等
- 2 本機は水平に設置して、クレーン作業を行ってください。
- 3 作業半径は、クレーンの旋回中心から荷重の重心までの水平距離です。
- 4 メインブームの定格総荷重は折りたたみ式ジブを取り除いた状態での値です。
- 5 53.5トンを超える定格総荷重の場合は、特殊吊装置が必要です。

メインブーム定格総荷重表

LTM 1080NX



11.0m—50.0m

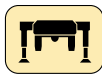

8.0x6.3

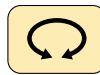

360°

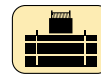

14.5t

メインブーム長さ 作業半径(m)	11.0m	14.6m	18.2m	21.8m	25.4m	28.9m	32.5m	36.1m	39.7m	43.3m	46.9m	50.0m	
2.5	80.0												
3.0	66.7	56.2	56.0	53.7									
3.5	59.8	51.0	51.0	51.2	42.8	35.1							
4.0	53.6	46.7	46.6	46.8	42.0	34.6	28.2						
4.5	48.4	42.8	42.8	43.0	41.0	34.1	27.9	22.7					
5	43.3	39.3	39.4	39.5	38.9	33.5	27.6	22.6	18.0				
6	35.4	33.5	34.0	34.1	34.1	31.8	27.0	22.1	17.7				
7	29.8	28.9	29.4	29.6	29.5	29.1	26.4	21.5	17.6	14.3	11.2		
8	25.3	24.9	25.4	25.6	25.6	24.4	22.9	20.2	17.4	14.1	11.1	8.8	
9			22.4	22.3	21.9	20.8	19.6	18.4	16.6	13.9	10.9	8.7	7.3
10			19.6	19.8	19.0	18.1	17.2	16.7	15.5	13.4	10.7	8.6	7.3
12			15.2	15.4	14.8	14.4	13.9	13.2	12.7	12.0	10.0	8.2	7.1
14				12.2	12.1	11.7	11.4	10.8	10.4	9.7	9.2	7.8	6.9
16				9.6	10.1	9.7	9.5	9.0	8.7	8.5	7.9	7.2	6.5
18					8.3	8.4	8.0	7.8	7.6	7.2	6.8	6.6	6.1
20						7.0	6.8	6.9	6.5	6.1	6.0	5.6	5.5
22						6.1	5.9	6.0	5.6	5.4	5.2	4.8	4.7
24							5.2	5.0	4.9	4.8	4.5	4.1	4.0
26								4.6	4.4	4.3	4.1	3.9	3.4
28									3.9	3.8	3.6	3.4	2.9
30									3.4	3.3	3.1	2.9	2.5
32										2.9	2.7	2.5	2.1
34											2.4	2.2	1.9
36												2.0	1.8
38													1.5
40													1.3
I	0	0/ 0/ 0	0/ 0/ 0	46/ 0/ 0	0/ 0/ 0	46/ 0/ 0	92/ 0/ 0	92/ 0/ 0	92/46/ 0	92/46	92	100	
II	0	46/ 0/ 0	46/ 0/ 0	46/ 0/ 0	46/ 0/ 0	46/46/ 0	46/46/ 0	46/92/46	92/92/92	92/92	92	100	
III	0	0/ 0/ 0	46/46/ 0	46/46/46	46/92/46	46/46/46	46/46/92	92/46/92	46/46/92	92/92	92	100	
IV	0	0/46/ 0	0/46/46	0/46/ 0	46/ 0/46	46/46/92	46/92/92	0/92/92	46/92/92	46/92	92	100	
V	0	0/ 0/46	0/ 0/46	0/46/92	46/92/92	46/92/92	46/92/92	92/92/92	92/92/92	92/92	92	100	

*後方吊り

t189-05002/05024



11.0m—50.0m



8.0x6.3



±60°

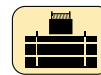

14.5t

メインブーム長さ 作業半径(m)	11.0m	14.6m	18.2m	21.8m	25.4m	28.9m	32.5m	36.1m	39.7m	43.3m	46.9m	50.0m	
3.0	56.2	56.0	53.7										
3.5	51.0	51.0	51.2	42.8	35.1								
4.0	46.7	46.6	46.8	42.0	34.6	28.2							
4.5	42.8	42.8	43.0	41.0	34.1	27.9	22.7						
5	39.3	39.4	39.5	38.9	33.5	27.6	22.6	18.0					
6	33.5	34.0	34.1	34.1	31.8	27.0	22.1	17.7					
7	28.9	29.4	29.6	29.6	29.9	26.4	21.5	17.6	14.3	11.2			
8	24.9	25.4	25.6	26.0	25.3	23.8	20.2	17.4	14.1	11.1	8.8		
9		22.4	22.4	22.8	21.8	20.6	18.7	16.6	13.9	10.9	8.7	7.3	
10		19.8	20.1	20.0	19.1	18.0	17.2	15.6	13.4	10.7	8.6	7.3	
12		15.6	16.0	15.7	15.1	14.4	14.0	13.4	12.2	10.0	8.2	7.1	
14			12.7	12.8	12.5	12.1	11.6	11.2	10.6	9.2	7.8	6.9	
16				10.1	10.6	10.5	10.3	9.8	9.4	8.8	8.5	7.2	6.5
18					8.9	8.8	8.7	8.3	7.9	7.9	7.3	6.7	6.1
20						7.6	7.5	7.4	7.1	6.8	6.3	6.1	5.6
22						6.6	6.3	6.4	6.2	5.9	5.7	5.4	5.1
24							5.5	5.6	5.3	5.1	5.1	4.7	4.6
26								4.9	4.8	4.8	4.4	4.0	4.0
28									4.3	4.2	4.0	3.9	3.5
30										3.9	3.7	3.5	3.0
32											3.3	3.1	2.9
34												2.8	2.6
36													2.4
38													
40													1.9
42													1.6
44													1.1
I	0	0/ 0/ 0	0/ 0/ 0	46/ 0/ 0	0/ 0/ 0	46/46/ 0	96/46/ 0	92/92/ 0	92/46/ 0	92/46	92	100	
II	0	46/ 0/ 0	46/ 0/ 0	46/46/ 0	46/ 0/ 0	46/46/46	46/46/46	46/46/92	92/92/92	92/92	92	100	
III	0	0/ 0/ 0	46/46/ 0	46/46/46	46/92/46	46/46/46	46/46/46	46/92/46	46/46/92	92/92	92	100	
IV	0	0/46/ 0	0/46/46	0/46/46	46/ 0/46	46/ 0/46	46/46/92	46/ 0/92	46/92/92	46/92	92	100	
V	0	0/ 0/46	0/ 0/46	0/ 0/46	46/92/92	46/92/92	46/92/92	92/92/92	92/92/92	92/92	92	100	

t189-05004

メインブーム定格総荷重表

LTM 1080NX

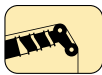

11.0m—50.0m

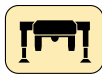

8.0x6.3

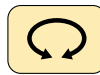

360°

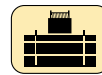

10.7t

メインブーム長さ 作業半径(m)	11.0m	14.6m	18.2m	21.8m	25.4m	28.9m	32.5m	36.1m	39.7m	43.3m	46.9m	50.0m	
3.0	50.9	50.8	48.8										
3.5	46.1	46.1	46.3	38.9	31.9								
4.0	42.1	42.1	42.3	38.1	31.4	25.6							
4.5	38.4	38.4	38.6	37.3	31.0	25.3	20.6						
5	35.2	35.4	35.4	35.2	30.4	25.1	20.5	16.3					
6	29.9	30.4	30.6	30.5	28.9	24.5	20.1	16.1					
7	25.4	25.8	26.0	26.0	25.3	23.3	19.6	16.0	13.0	10.2			
8	21.5	22.2	22.3	22.4	21.1	19.7	18.1	15.8	12.8	10.1	8.0		
9		19.0	19.4	18.9	17.9	17.0	16.4	15.0	12.6	9.9	7.9	6.7	
10		15.8	16.3	16.3	15.5	14.9	14.3	13.6	12.2	9.7	7.8	6.6	
12		11.5	12.0	12.2	12.1	11.9	11.4	10.9	10.1	9.1	7.5	6.5	
14			9.2	9.5	9.7	9.5	9.2	8.7	8.6	8.0	7.1	6.2	
16			7.4	7.7	7.8	7.6	7.7	7.5	7.1	6.8	6.4	5.9	
18				6.4	6.4	6.4	6.4	6.2	6.0	5.8	5.4	5.2	
20					5.4	5.5	5.4	5.3	5.1	4.9	4.5	4.3	
22					4.5	4.7	4.6	4.5	4.3	4.1	3.8	3.6	
24						4.0	3.9	3.9	3.7	3.5	3.1	3.0	
26						3.4	3.3	3.3	3.1	2.9	2.6	2.5	
28							2.8	2.8	2.6	2.5	2.2	2.1	
30							2.5	2.4	2.2	2.1	1.8	1.7	
32								2.0	1.8	1.7	1.4	1.4	
34									1.5	1.4	1.1	1.1	
36									1.3	1.1	0.8	0.8	
38										0.8			
ブーム伸長率 (%)	I	0	0/ 0/ 0	0/ 0/ 0	46/ 0/ 0	0/ 0/ 0	46/ 0/ 0	92/ 0/ 0	92/ 0/ 0	92/46/ 0	92/46	92	100
	II	0	46/ 0/ 0	46/ 0/ 0	46/ 0/ 0	46/ 0/ 0	46/46/ 0	46/46/ 0	46/92/46	92/92/92	92/92	92	100
	III	0	0/ 0/ 0	46/46/ 0	46/46/46	46/92/46	46/46/46	46/46/46	92/46/92	46/46/92	92/92	92	100
	IV	0	0/46/ 0	0/46/46	0/46/ 0	46/ 0/46	46/46/92	46/92/92	0/92/92	46/92/92	46/92	92	100
	V	0	0/ 0/46	0/ 0/46	0/46/92	46/92/92	46/92/92	46/92/92	92/92/92	92/92/92	92/92	92	100

t189-00032



11.0m—50.0m



8.0x6.3

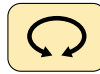

±60°

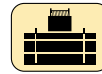

10.7t

メインブーム長さ 作業半径(m)	11.0m	14.6m	18.2m	21.8m	25.4m	28.9m	32.5m	36.1m	39.7m	43.3m	46.9m	50.0m	
3.0	50.9	50.8	48.8										
3.5	46.1	46.1	46.3	38.9	31.9								
4.0	42.1	42.1	42.3	38.1	31.4	25.6							
4.5	38.4	38.4	38.6	37.3	31.0	25.3	20.6						
5	35.2	35.4	35.4	35.2	30.4	25.1	20.5	16.3					
6	29.9	30.4	30.6	30.5	28.9	24.5	20.1	16.1					
7	25.4	25.8	26.0	26.0	26.3	24.0	19.6	16.0	13.0	10.2			
8	21.5	22.3	22.4	22.8	22.4	21.0	18.3	15.8	12.8	10.1	8.0		
9		19.3	19.7	19.8	19.2	18.1	16.9	15.1	12.6	9.9	7.9	6.7	
10		16.7	17.2	17.2	16.8	16.0	15.5	14.2	12.2	9.7	7.8	6.6	
12		12.4	12.9	12.9	13.0	12.9	12.4	11.8	11.1	9.1	7.5	6.5	
14			10.0	10.3	10.2	10.3	10.1	9.7	9.1	8.4	7.1	6.2	
16			8.1	8.3	8.5	8.4	8.2	8.0	7.9	7.3	6.6	5.9	
18				7.0	7.1	6.9	6.9	6.9	6.7	6.2	6.0	5.5	
20					6.0	5.9	6.0	5.8	5.6	5.5	5.1	4.9	
22					5.1	5.2	5.1	5.0	4.9	4.7	4.3	4.2	
24						4.5	4.4	4.4	4.2	4.0	3.7	3.5	
26						3.9	3.8	3.8	3.6	3.4	3.1	3.0	
28							3.3	3.3	3.1	2.9	2.6	2.5	
30							2.9	2.8	2.7	2.5	2.2	2.1	
32								2.4	2.3	2.1	1.9	1.8	
34									1.9	1.8	1.5	1.5	
36									1.6	1.5	1.2	1.2	
38										1.2	0.9	0.9	
40										1.0			
ブーム伸長率 (%)	I	0	0/ 0/ 0	0/ 0/ 0	46/ 0/ 0	0/ 0/ 0	46/ 0/ 0	96/46/ 0	92/46/ 0	92/46/ 0	92/46	92	100
	II	0	46/ 0/ 0	46/ 0/ 0	46/46/ 0	46/ 0/ 0	46/46/ 0	46/46/46	46/92/46	92/92/92	92/92	92	100
	III	0	0/ 0/ 0	46/46/ 0	46/46/46	46/92/46	46/46/46	46/46/46	92/46/92	46/46/92	92/92	92	100
	IV	0	0/46/ 0	0/46/46	0/46/46	46/ 0/46	46/46/92	46/46/92	0/46/92	46/92/92	46/92	92	100
	V	0	0/ 0/46	0/ 0/46	0/ 0/46	46/92/92	46/92/92	46/92/92	92/92/92	92/92/92	92/92	92	100

t189-00012

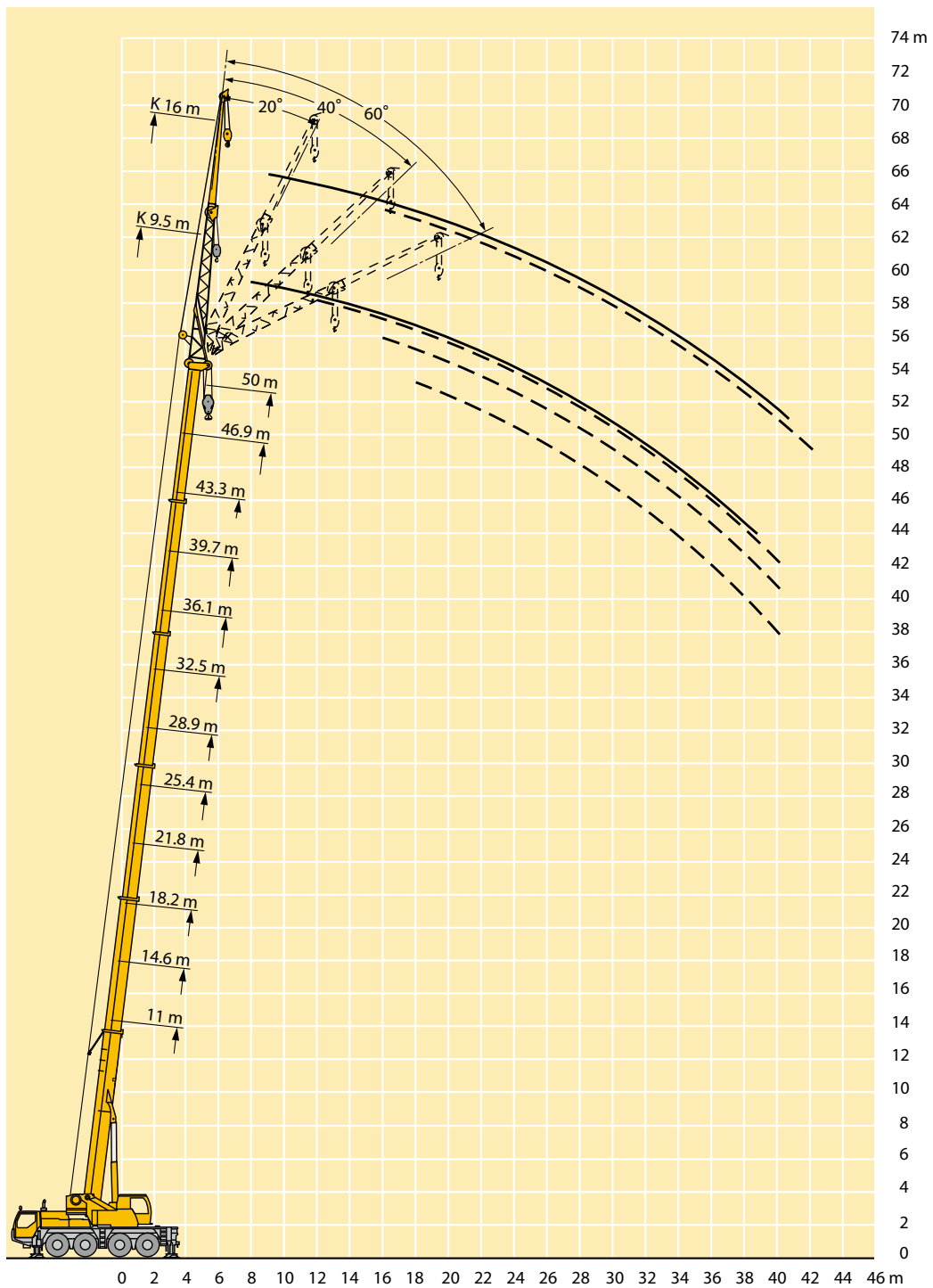

注意

- 1 定格総荷重はフックブロック、玉掛ワイヤー等の自重を含みます。
また、下記の条件が考慮されていませんのでクレーンの操作には充分気をつけてください。
 - ① 地盤の強度、地震による影響
 - ② 作業速度に応じた動荷重および台風または強風による影響等
- 2 本機は水平に設置して、クレーン作業を行ってください。
- 3 作業半径は、クレーンの旋回中心から荷重の重心までの水平距離です。
- 4 メインブームの定格総荷重は折りたたみ式ジブを取り除いた状態での値です。
- 5 53.5トンを超える定格総荷重の場合は、特殊吊装置が必要です。

油圧チルトジブ定格総荷重表

LTM 1080NX



11.0m—50.0m

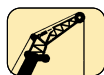

9.5m



8.0x6.3



360°

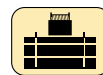

14.5t

メインブーム長さ	11.0m				14.6m				18.2m				21.8m				25.4m				28.9m							
ジブ長さ	9.5m				9.5m				9.5m				9.5m				9.5m				9.5m							
作業半径(m) \ 角度	0°	20°	40°	60°	0°	20°	40°	60°	0°	20°	40°	60°	0°	20°	40°	60°	0°	20°	40°	60°	0°	20°	40°	60°	0°	20°	40°	60°
3	11.4				11.4				11.4				11.4				11.4											
3.5	11.4				11.4				11.4				11.4				11.4							11.4				
4	11.4	10.4			11.4				11.4				11.4				11.4						11.4					
4.5	11.4	10.0			11.4	10.3			11.4				11.4				11.4					11.4						
5	11.4	9.6			11.4	10.0			11.4	10.1			11.4				11.4					11.4						
6	11.4	8.9			11.4	9.3			11.4	9.5			11.4	9.5			11.4	9.5				11.4						
7	11.4	8.3	6.8		11.4	8.8	6.9		11.4	9.1			11.4	9.1			11.4	9.1				11.4	9.1			11.4	8.8	
8	11.1	7.8	6.5	5.3	11.4	8.3	6.7		11.4	8.6	6.7		11.4	8.7	6.7		11.4	8.7				11.4	8.7			11.4	8.5	
9	10.4	7.4	6.2	5.1	11.4	7.9	6.5	5.2	11.4	8.2	6.6	5.3	11.4	8.3	6.6		11.4	8.4	6.6			11.4	8.4	6.6		11.4	8.2	
10	9.5	7.1	6.0	5.0	10.9	7.5	6.2	5.1	11.4	7.8	6.4	5.1	11.4	8.0	6.4	5.2	11.4	8.1	6.5	5.2		11.4	8.1	6.5	5.2	11.4	8.0	6.3
12	7.8	6.4	5.6	4.8	9.5	6.9	5.8	4.9	10.6	7.3	6.0	5.0	11.0	7.4	6.0	5.0	11.2	7.6	6.1	5.0	10.9	7.5	6.0	5.0	10.9	7.5	6.0	5.0
14	6.4	5.8	5.3	4.8	8.0	6.4	5.5	4.8	9.3	6.8	5.7	4.9	9.8	7.0	5.8	4.9	10.0	7.2	5.8	4.9	10.0	7.2	5.8	4.9	10.0	7.1	5.8	4.9
16	5.4	5.5	5.2	4.8	6.8	5.9	5.3	4.8	8.1	6.4	5.5	4.8	8.8	6.6	5.6	4.8	8.3	6.8	5.6	4.8	8.3	6.8	5.6	4.8	8.4	6.8	5.6	4.9
18	4.7	5.3			5.8	5.6	5.2	4.8	6.9	5.9	5.3	4.8	7.5	6.3	5.4	4.8	6.9	6.4	5.5	4.8	7.0	6.5	5.5	4.8	7.0	6.5	5.5	4.8
20					5.1	5.4	5.1		6.1	5.7	5.2	4.8	6.4	5.9	5.3	4.8	5.8	6.0	5.4	4.8	5.8	5.9	5.1	4.8	5.9	6.1	5.4	4.8
22									5.4	5.5	5.2	4.8	5.4	5.6	5.2	4.8	4.9	5.2	5.3	4.8	4.9	5.2	5.3	4.8	5.0	5.4	5.3	4.8
24									4.8	4.9	4.9						4.6	4.8	4.9	4.8	4.1	4.4	4.7	4.7	4.3	4.6	4.9	4.8
26													3.9	4.1	4.1	3.9	3.5	3.8	3.9	3.9	3.7	4.0	4.2	4.2	3.7	4.0	4.2	4.2
28													3.3	3.4	3.3		2.9	3.2	3.2	3.1	3.2	3.4	3.5	3.6	3.2	3.4	3.5	3.6
30																	2.4	2.6	2.6		2.7	2.9	3.0	3.0	2.7	2.9	3.0	3.0
32																	2.0	2.1			2.3	2.4	2.5	2.3	1.9	2.0	2.0	2.3
34																					1.9	2.0	2.0	2.0	1.6	1.6	1.6	1.6
36																					1.6	1.6	1.6	1.6	1.6	1.6	1.6	1.6
ブーム伸長率 (%)	I	0				0				0/0				0				46				46						
	II	0				46				46/0				46				46				46						
	III	0				0				46/92				92				92				46						
	IV	0				0				0/0				0				0				46						
	V	0				0				0/0				0				0				46						

t189-05064/05072/05080/05088



11.0m—50.0m



9.5m



8.0x6.3



360°

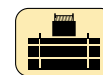

14.5t

メインブーム長さ	32.5m				36.1m				39.7m				43.3m				46.9m				50.0m							
ジブ長さ	9.5m				9.5m				9.5m				9.5m				9.5m				9.5m							
作業半径(m) \ 角度	0°	20°	40°	60°	0°	20°	40°	60°	0°	20°	40°	60°	0°	20°	40°	60°	0°	20°	40°	60°	0°	20°	40°	60°	0°	20°	40°	60°
4.5	11.4																											
5	11.4					8.9																						
6	11.4					8.7				7.6																		
7	11.4					8.4				7.4				5.2				4.6										
8	11.3	8.3				8.2				7.3				5.2				4.6							3.9			
9	11.1	8.0				8.1	7.1			7.1				5.2				4.6							3.9			
10	10.8	7.8	6.3			7.9	7.1			7.0	6.1			5.1	4.6			4.6							3.9			
12	10.3	7.4	6.0	5.0		7.6	6.8	5.9		6.7	6.0	5.6		5.0	4.5			4.5	4.1					3.8	3.5			
14	9.4	7.1	5.8	4.9		7.2	6.4	5.7	4.9	6.4	5.8	5.6	4.9	4.8	4.5	4.4		4.4	4.0	3.9				3.7	3.4			
16	7.7	6.8	5.8	4.9		6.7	5.9	5.4	4.8	6.1	5.7	5.4	4.8	4.7	4.3	4.4	4.4	4.2	4.0	3.9				4.0	3.6	3.4	3.3	
18	6.4	6.6	5.5	4.8		6.2	5.6	5.2	4.8	5.9	5.4	5.1	4.8	4.4	4.2	4.2	4.2	4.1	3.9	3.9				4.0	3.5	3.4	3.3	3.4
20	5.7	5.8	5.4	4.8		5.6	5.2	4.9	4.7	5.1	5.2	4.9	4.7	4.1	4.0	3.9	4.0	3.9	3.9	3.8				3.9	3.4	3.4	3.3	3.4
22	5.1	4.9	5.3	4.8		4.7	4.9	4.7	4.7	4.3	4.8	4.7	4.6	3.9	3.8	3.7	3.8	3.7	3.7	3.6				3.7	3.3	3.3	3.2	3.3
24	4.4	4.5	4.4	4.6		4.1	4.4	4.5	4.5	3.6	4.1	4.4	4.4	3.7	3.5	3.5	3.5	3.5	3.5	3.5				3.5	3.2	3.2	3.1	3.2
26	3.8	4.1	4.2	4.3	3.5	3.8	4.0	4.2	4.2	3.4	3.4	3.7	3.8	3.3	3.3	3.3	3.4	3.0	3.2	3.3				3.3	2.9	3.0	3.0	3.0
28	3.3	3.5	3.7	3.8	3.0	3.2	3.5	3.6	3.1	3.1	3.1	3.2	2.9	3.1	3.1	3.2	2.5	2.8	3.0	3.1				2.4	2.7	2.8	2.9	
30	2.9	3.0	3.2	3.3	2.5	2.7	3.0	3.0	2.7	2.9	2.9	3.0	2.4	2.7	2.9	2.9	2.1	2.4	2.6	2.7				2.0	2.3	2.5	2.6	
32	2.5	2.6	2.8	2.7	2.1	2.3	2.5	2.5	2.3	2.5	2.7	2.7	2.1	2.3	2.4	2.5	1.7	2.0	2.1	2.2				1.6	1.9	2.1	2.2	
34	2.1	2.2	2.3	2.2	1.8	2.0	2.1	2.1	2.0	2.2	2.3	2.3	1.7	1.9	2.1	2.1	1.4	1.6	1.8	1.8				1.3	1.5	1.7	1.8	
36	1.7	1.9	1.9	1.7	1.5	1.6	1.8	1.7	1.7	1.9	1.9	2.0	1.4	1.6	1.7	1.8	1.1	1.3	1.4	1.5				1.0	1.2	1.4	1.4	
38	1.5	1.5	1.5		1.2	1.3	1.4	1.3	1.4	1.6	1.6	1.6	1.2	1.3	1.4	1.4	0.8	1.0	1.1	1.2				0.8	1.0	1.1	1.1	
40					0.9	1.0	1.1	0.9	1.2	1.3	1.3	1.3	0.9	1.1	1.2	1.1	0.6	0.8	0.9	0.9				0.7	0.8	0.8	0.8	
42					0.7	0.8	0.7		0.9	1.0	1.0	0.9	0.7	0.8	0.9	0.8				0.6	0.6							
44									0.7	0.8	0.8						0.6											
ブーム伸長率 (%)	I	92/0				46				92/0				46				92				100						
	II	46/92				92				92/92				92				92				100						
	III	46/46				46				46/92				92				92				100						
	IV	46/46				46				46/92				92				92				100						
	V	46/92				92				92/92				92				92				100						

t189-05064/05072/05080/05088

油圧チルトジブ定格総荷重表

LTM 1080NX



11.0m—50.0m

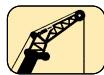

16m



8.0x6.3



360°

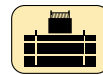

14.5t

メインboom長さ	11.0m				14.6m				18.2m				21.8m				25.4m				28.9m							
ジブ長さ	16m				16m				16m				16m				16m				16m							
作業半径(m) \ 角度	0°	20°	40°	60°	0°	20°	40°	60°	0°	20°	40°	60°	0°	20°	40°	60°	0°	20°	40°	60°	0°	20°	40°	60°	0°	20°	40°	60°
3.0	8.3				8.3				8.1																			
3.5	8.1				8.2				8.1				7.6															
4.0	7.8				8.1				8.0				7.5				7.3							6.0				
4.5	7.5				7.8				7.8				7.4				7.2							6.0				
5	7.2				7.6				7.7				7.3				7.1							6.0				
6	6.6				7.0				7.2				7.1				7.0							6.0				
7	6.1	4.3			6.5				6.8				6.7				6.7							6.0				
8	5.6	4.1			6.1	4.2			6.4	4.2			6.3				6.4							5.9				
9	5.1	3.8			5.6	4.0			6.0	4.0			6.0	4.1			6.1	4.1						5.7				
10	4.8	3.6			5.2	3.8			5.6	3.9			5.7	3.9			5.7	3.9						5.6	3.9			
12	4.2	3.3	2.8		4.6	3.5	2.8		4.9	3.6	2.9		5.1	3.6			5.3	3.7						5.3	3.6			
14	3.8	3.0	2.6	2.5	4.2	3.2	2.7		4.5	3.3	2.7		4.6	3.4	2.7		4.8	3.4	2.7					4.9	3.4	2.7		
16	3.4	2.8	2.5	2.4	3.8	3.0	2.5	2.4	4.1	3.1	2.6	2.5	4.3	3.2	2.6	2.4	4.4	3.3	2.6					4.6	3.2	2.6		
18	3.1	2.6	2.4	2.4	3.4	2.8	2.5	2.4	3.7	2.9	2.5	2.4	3.9	3.0	2.5	2.4	4.1	3.1	2.6	2.4	4.3	3.1	2.5	2.4			2.4	
20	2.8	2.5	2.3	2.4	3.1	2.6	2.4	2.4	3.4	2.7	2.4	2.4	3.6	2.8	2.4	2.4	3.9	2.9	2.5	2.4	4.1	2.9	2.5	2.4			2.4	
22	2.6	2.3	2.3		2.9	2.5	2.3	2.4	3.2	2.6	2.3	2.3	3.4	2.7	2.4	2.3	3.6	2.8	2.4	2.3	3.8	2.8	2.5	2.4			2.3	
24	2.4	2.3			2.7	2.4	2.3	2.4	2.9	2.5	2.3	2.3	3.1	2.6	2.3	2.3	3.3	2.6	2.4	2.3	3.6	2.7	2.4	2.3			2.3	
26					2.5	2.3	2.3		2.7	2.4	2.3	2.3	2.9	2.5	2.3	2.3	3.1	2.5	2.3	2.3	3.4	2.6	2.3	2.3			2.3	
28					2.3	2.3			2.5	2.3	2.3	2.3	2.7	2.4	2.3	2.3	2.9	2.5	2.3	2.3	3.2	2.5	2.3	2.3			2.3	
30									2.4	2.3	2.3		2.6	2.3	2.3	2.3	2.8	2.4	2.3	2.3	3.0	2.4	2.3	2.3			2.3	
32													2.4	2.3	2.3		2.5	2.3	2.3	2.3	2.7	2.4	2.3	2.3			2.3	
34													2.3	2.3			2.1	2.3	2.3	2.3	2.3	2.3	2.2	2.3			2.3	
36																	1.8	2.0	2.0		2.0	2.2	2.2	2.2			2.2	
38																	1.5	1.6			1.7	1.9	1.9	1.6			1.6	
40																					1.4	1.5	1.5				1.5	
42																					1.2	1.2					1.2	
boom伸長率 (%)	I	0				0				0/0				0				46				46						
	II	0				46				46/0				46				46				46						
	III	0				0				46/92				92				92				46						
	IV	0				0				0/0				0				0				46						
	V	0				0				0/0				0				0				46						

t189-05096/05104/05112/05120



11.0m—50.0m

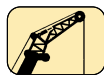

16m



8.0x6.3



360°

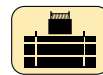

14.5t

メインboom長さ	32.5m				36.1m				39.7m				43.3m				46.9m				50.0m		
ジブ長さ	16m				16m				16m				16m				16m				16m		
作業半径(m) \ 角度	0°	20°	40°	60°	0°	20°	40°	60°	0°	20°	40°	60°	0°	20°	40°	60°	0°	20°	40°	60°	0°	20°	
5	5.6																						
6	5.6				4.8																		
7	5.6				4.8				4.4														
8	5.6				4.8				4.4				3.6										
9	5.5				4.8				4.3				3.5									2.8	
10	5.4				4.7				4.3				3.4									2.7	
12	5.1	3.6			4.6	3.4			4.2				3.3									2.6	
14	4.9	3.4			4.4	3.3			4.1	3.2			3.2	2.9								2.5	
16	4.6	3.3	2.6		4.2	3.2	2.6		3.9	3.1			3.1	2.9								2.5	2.3
18	4.3	3.1	2.6	2.4	4.1	3.0	2.5		3.8	3.0	2.5		3.0	2.8	2.4							2.4	2.2
20	4.1	3.0	2.5	2.4	3.9	2.9	2.5	2.3	3.7	2.9	2.4	2.3	3.0	2.7	2.4							2.4	2.2
22	3.9	2.8	2.4	2.3	3.7	2.8	2.4	2.3	3.6	2.8	2.4	2.3	2.9	2.7	2.3	2.3						2.3	2.2
24	3.7	2.7	2.4	2.3	3.6	2.7	2.4	2.3	3.5	2.7	2.3	2.3	2.9	2.6	2.3	2.3						2.3	2.2
26	3.5	2.6	2.3	2.3	3.4	2.6	2.3	2.3	3.3	2.6	2.3	2.3	2.8	2.5	2.3	2.2						2.2	2.2
28	3.2	2.5	2.3	2.3	3.2	2.5	2.3	2.3	3.2	2.5	2.3	2.3	2.7	2.5	2.2	2.2						2.2	2.2
30	3.1	2.5	2.3	2.3	2.8	2.5	2.3	2.3	2.6	2.5	2.2	2.3	2.5	2.4	2.2	2.2						2.2	2.1
32	2.7	2.4	2.3	2.3	2.4	2.4	2.2	2.3	2.4	2.4	2.2	2.3	2.2	2.3	2.2	2.2						2.2	2.1
34	2.4	2.3	2.2	2.3	2.1	2.3	2.2	2.3	2.2	2.2	2.2	2.3	1.9	2.2	2.1	2.2						2.2	2.1
36	2.1	2.3	2.2	2.3	1.8	2.1	2.2	2.3	1.9	2.1	2.1	2.2	1.6	1.9	2.1	2.2						2.1	1.6
38	1.8	2.0	2.1	2.1	1.5	1.8	1.9	2.0	1.6	1.9	2.0	2.1	1.3	1.6	1.9	2.0						1.7	1.3
40	1.5	1.7	1.8	1.6	1.3	1.5	1.6	1.6	1.4	1.6	1.8	1.8	1.1	1.4	1.6	1.6						1.4	1.0
42	1.3	1.4	1.4		1.0	1.2	1.3	1.2	1.2	1.4	1.5	1.5	0.9	1.1	1.3	1.3						1.1	0.8
44	1.1	1.2	1.1		0.8	1.0	1.0	0.8	1.0	1.1	1.2	1.2	0.7	0.9	1.1	1.1						0.8	0.8
46	0.9				0.6	0.7	0.7		0.8	0.9	1.0	0.9		0.7	0.8	0.8							
48										0.7	0.7					0.6							
boom伸長率 (%)	I	92/0				46				92/0				46				92				100	
	II	46/92				92				92/92				92				92				100	
	III	46/46				46				46/92				92				92				100	
	IV	46/46				46				46/92				92				92				100	
	V	46/92				92				92/92				92				92				100	

t189-05096/05104/05112/05120

油圧チルトジブ定格総荷重表

LTM 1080NX

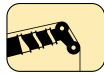

11.0m—50.0m

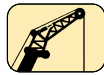

9.5m



8.0x6.3



360°

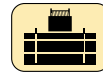

10.7t

メインboom長さ	11.0m				14.6m				18.2m				21.8m				25.4m				28.9m							
ジブ長さ	9.5m				9.5m				9.5m				9.5m				9.5m				9.5m							
作業半径(m) \ 角度	0°	20°	40°	60°	0°	20°	40°	60°	0°	20°	40°	60°	0°	20°	40°	60°	0°	20°	40°	60°	0°	20°	40°	60°	0°	20°	40°	60°
3	11.4				11.4				11.4				11.4				11.4											
3.5	11.4				11.4				11.4				11.4				11.4							11.4				
4.0	11.4	9.4			11.4				11.4				11.4				11.4						11.4					
4.5	11.4	9.1			11.4	9.4			11.4				11.4				11.4						11.4					
5	11.4	8.7			11.4	9.1			11.4	9.2			11.4				11.4						11.4					
6	11.3	8.1			11.4	8.5			11.4	8.7			11.4	8.7			11.4	8.7					11.4					
7	10.8	7.6	6.2		11.4	8.0	6.3		11.4	8.2			11.4	8.3			11.4	8.3					11.2	8.0				
8	10.1	7.1	5.9	4.8	11.1	7.5	6.1		11.4	7.8	6.1		11.2	7.9	6.1		11.4	8.0					11.0	7.7				
9	9.4	6.7	5.7	4.7	10.5	7.2	5.9	4.7	11.3	7.5	6.0	4.8	11.0	7.5	6.0		11.2	7.7	6.0				10.8	7.5				
10	8.7	6.4	5.4	4.5	9.9	6.8	5.7	4.6	10.8	7.1	5.8	4.7	10.7	7.2	5.8	4.7	10.9	7.4	5.9	4.7			10.6	7.2	5.7			
12	7.0	5.8	5.1	4.4	8.6	6.3	5.3	4.5	9.6	6.6	5.4	4.5	10.0	6.8	5.5	4.6	10.2	6.9	5.6	4.6			9.9	6.8	5.4	4.6		
14	5.8	5.3	4.8	4.4	7.3	5.8	5.0	4.4	8.4	6.2	5.2	4.4	8.9	6.4	5.2	4.4	8.4	6.5	5.3	4.5			8.5	6.5	5.3	4.5		
16	4.9	5.0	4.7	4.4	6.1	5.4	4.8	4.4	7.3	5.8	5.0	4.4	7.4	6.0	5.1	4.4	6.8	6.1	5.1	4.4			6.9	6.2	5.1	4.4		
18	4.3	4.8			5.2	5.1	4.7	4.4	6.1	5.4	4.8	4.4	6.0	5.7	4.9	4.4	5.6	5.8	5.0	4.4			5.7	5.9	5.0	4.4		
20					4.6	4.9	4.7		5.1	5.1	4.7	4.4	4.9	5.2	4.8	4.4	4.6	5.0	4.9	4.4			4.8	5.2	4.9	4.4		
22									4.2	4.4	4.5	4.3	4.0	4.3	4.5	4.4	3.7	4.0	4.3	4.3			4.0	4.3	4.6	4.4		
24									3.5	3.6	3.6		3.3	3.6	3.7	3.6	3.0	3.3	3.5	3.5			3.3	3.6	3.8	3.9		
26													2.8	2.9	3.0	2.8	2.4	2.6	2.8	2.8			2.7	2.9	3.1	3.2		
28													2.3	2.4	2.3		1.9	2.1	2.2	2.1			2.2	2.4	2.5	2.5		
30																	1.5	1.6	1.6				1.8	1.9	2.0	2.0		
32																	1.2	1.2					1.4	1.5	1.6	1.5		
34																							1.1	1.2	1.2			
36																							0.9	0.9				
38																												
40																												
boom伸長率 (%)	I	0				0				0/0				0				46				46						
	II	0				46				46/0				46				46				46						
	III	0				0				46/92				92				92				46						
	IV	0				0				0/0				0				0				46						
	V	0				0				0/0				0				0				46						

t189-00068/00076/00084/00092

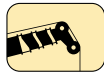

11.0m—50.0m

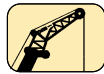

9.5m



8.0x6.3



360°

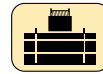

10.7t

メインboom長さ	32.5m				36.1m				39.7m				43.3m				46.9m				50.0m							
ジブ長さ	9.5m				9.5m				9.5m				9.5m				9.5m				9.5m							
作業半径(m) \ 角度	0°	20°	40°	60°	0°	20°	40°	60°	0°	20°	40°	60°	0°	20°	40°	60°	0°	20°	40°	60°	0°	20°	40°	60°	0°	20°	40°	60°
4.5	11.0																											
5	10.9				8.0																							
6	10.7				7.9				6.9																			
7	10.5				7.7				6.8				4.7				4.2											
8	10.3	7.5			7.5				6.6				4.7				4.2							3.6				
9	10.1	7.3			7.3	6.5			6.5				4.7				4.2						3.5					
10	9.9	7.1	5.7		7.2	6.4			6.3	5.6			4.7	4.2			4.1						3.5					
12	9.4	6.8	5.5	4.6	6.9	6.2	5.4		6.1	5.5	5.1		4.5	4.1			4.1	3.7				3.4	3.2					
14	7.8	6.5	5.2	4.5	6.5	5.8	5.2	4.4	5.8	5.3	5.0	4.4	4.4	4.1	4.0		4.0	3.7	3.6			3.4	3.1					
16	6.3	6.2	5.1	4.4	6.1	5.4	5.0	4.4	5.6	5.2	4.9	4.4	4.2	3.9	4.0	4.0	3.8	3.6	3.6	3.7		3.3	3.1	3.0				
18	5.7	5.7	5.0	4.4	5.4	5.1	4.7	4.3	4.9	4.9	4.6	4.4	4.0	3.8	3.8	3.8	3.7	3.6	3.5	3.7		3.2	3.1	3.0	3.1			
20	4.9	4.7	4.9	4.4	4.5	4.7	4.5	4.3	4.0	4.5	4.4	4.3	3.8	3.7	3.6	3.6	3.6	3.5	3.4	3.5		3.1	3.1	3.0	3.1			
22	4.1	4.4	4.2	4.3	3.7	4.1	4.3	4.2	3.5	3.8	4.1	4.2	3.5	3.4	3.4	3.4	3.2	3.3	3.3	3.3		3.0	3.0	2.9	3.0			
24	3.5	3.8	4.0	4.0	3.1	3.5	3.8	3.9	3.3	3.2	3.4	3.6	3.0	3.2	3.2	3.2	2.6	3.0	3.1	3.2		2.5	2.8	2.8	2.9			
26	2.9	3.1	3.4	3.4	2.6	2.9	3.2	3.3	2.8	3.0	3.0	3.0	2.5	2.8	3.0	3.0	2.1	2.5	2.8	2.9		2.0	2.4	2.6	2.8			
28	2.4	2.6	2.8	2.8	2.1	2.4	2.6	2.7	2.3	2.6	2.8	2.8	2.1	2.4	2.6	2.7	1.7	2.0	2.3	2.4		1.6	1.9	2.2	2.4			
30	2.0	2.1	2.3	2.3	1.7	2.0	2.2	2.2	2.0	2.2	2.4	2.4	1.7	1.9	2.1	2.2	1.3	1.6	1.8	2.0		1.3	1.6	1.8	1.9			
32	1.6	1.8	1.9	1.8	1.4	1.6	1.7	1.7	1.6	1.8	1.9	2.0	1.4	1.6	1.8	1.8	1.0	1.3	1.5	1.6		0.9	1.2	1.4	1.5			
34	1.3	1.4	1.5	1.4	1.1	1.2	1.4	1.3	1.3	1.5	1.6	1.6	1.1	1.3	1.4	1.5	0.7	1.0	1.1	1.2		0.7	0.9	1.1	1.1			
36	1.0	1.1	1.1	1.0	0.8	0.9	1.0	1.0	1.0	1.2	1.2	1.2	0.8	1.0	1.1	1.1		0.7	0.8	0.9		0.6	0.8	0.8				
38	0.8	0.8	0.8			0.7	0.7	0.6	0.8	0.9	1.0	0.9		0.7	0.8	0.8												
40									0.7	0.7	0.6																	
boom伸長率 (%)	I	92/0				46				92/0				46				92				100						
	II	46/92				92				92/92				92				92				100						
	III	46/46				46				46/92				92				92				100						
	IV	46/46				46				46/92				92				92				100						
	V	46/92				92				92/92				92				92				100						

t189-00068/00076/00084/00092

油圧チルトジブ定格総荷重表

LTM 1080NX

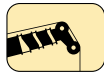

11.0m—50.0m

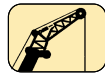

16m



8.0x6.3

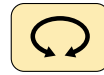

360°

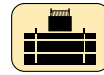

10.7t

メインboom長さ	11.0m				14.6m				18.2m				21.8m				25.4m				28.9m							
ジブ長さ	16m				16m				16m				16m				16m				16m							
作業半径(m)	角度				角度				角度				角度				角度				角度							
	0°	20°	40°	60°	0°	20°	40°	60°	0°	20°	40°	60°	0°	20°	40°	60°	0°	20°	40°	60°	0°	20°	40°	60°	0°	20°	40°	60°
3.0	7.6				7.6				7.4																			
3.5	7.4				7.5				7.3				6.9															
4.0	7.1				7.3				7.2				6.8				6.6							5.5				
4.5	6.8				7.1				7.1				6.7				6.5						5.5					
5	6.5				6.9				7.0				6.7				6.5						5.5					
6	6.0				6.4				6.6				6.4				6.3						5.5					
7	5.5	3.9			6.0				6.2				6.1				6.1						5.5					
8	5.1	3.7			5.5	3.8			5.8	3.9			5.7				5.8						5.4					
9	4.6	3.5			5.1	3.6			5.5	3.7			5.4	3.7			5.5	3.7					5.2					
10	4.4	3.3			4.7	3.4			5.1	3.5			5.1	3.5			5.2	3.6					5.1	3.5				
12	3.9	3.0	2.5		4.2	3.1	2.6		4.5	3.2	2.6		4.7	3.3			4.8	3.3					4.8	3.3				
14	3.4	2.8	2.4	2.3	3.8	2.9	2.4		4.1	3.0	2.5		4.2	3.1	2.5		4.4	3.1	2.5				4.5	3.1	2.5			
16	3.1	2.5	2.3	2.2	3.4	2.7	2.3	2.2	3.7	2.8	2.4	2.2	3.9	2.9	2.4	2.2	4.0	3.0	2.4				4.2	2.9	2.4			
18	2.8	2.4	2.2	2.1	3.1	2.5	2.2	2.2	3.4	2.6	2.3	2.2	3.6	2.7	2.3	2.2	3.8	2.8	2.3	2.2			3.9	2.8	2.3	2.2		
20	2.5	2.2	2.1	2.1	2.8	2.4	2.2	2.1	3.1	2.5	2.2	2.1	3.3	2.6	2.2	2.1	3.5	2.7	2.2	2.1			3.7	2.7	2.3	2.1		
22	2.3	2.1	2.1		2.6	2.2	2.1	2.1	2.9	2.4	2.1	2.1	3.1	2.4	2.2	2.1	3.2	2.5	2.2	2.1			3.5	2.6	2.2	2.1		
24	2.1	2.1			2.4	2.2	2.1	2.1	2.7	2.2	2.1	2.1	2.9	2.3	2.1	2.1	3.0	2.4	2.1	2.1			3.2	2.5	2.1	2.1		
26					2.2	2.1	2.1		2.5	2.2	2.1	2.1	2.7	2.2	2.1	2.1	2.8	2.3	2.1	2.1			3.0	2.4	2.1	2.1		
28					2.1	2.1			2.3	2.1	2.1	2.1	2.5	2.2	2.1	2.1	2.4	2.2	2.1	2.1			2.6	2.3	2.1	2.1		
30									2.2	2.1	2.1		2.3	2.1	2.1	2.1	2.0	2.2	2.1	2.1			2.2	2.2	2.1	2.1		
32													2.0	2.1	2.1		1.6	1.9	2.1	2.1			1.8	2.1	2.0	2.1		
34													1.7	1.8			1.3	1.6	1.7	1.5			1.5	1.8	1.9	1.9		
36																	1.0	1.2	1.2				1.2	1.4	1.5	1.5		
38																	0.8	0.9					1.0	1.1	1.2	0.9		
40																							0.8	0.9	0.9			
42																									0.6			
boom伸長率 (%)	I	0				0				0/0				0				46				46						
	II	0				46				46/0				46				46				46						
	III	0				0				46/92				92				92				46						
	IV	0				0				0/0				0				0				46						
	V	0				0				0/0				0				0				46						

t189-00100/00108/00116/00124

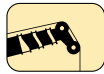

11.0m—50.0m

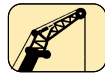

16m



8.0x6.3

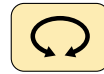

360°

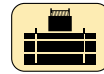

10.7t

メインboom長さ	32.5m				36.1m				39.7m				43.3m				46.9m				50.0m							
ジブ長さ	16m				16m				16m				16m				16m				16m							
作業半径(m)	角度				角度				角度				角度				角度				角度							
	0°	20°	40°	60°	0°	20°	40°	60°	0°	20°	40°	60°	0°	20°	40°	60°	0°	20°	40°	60°	0°	20°	0°	20°				
5	5.1																											
6	5.1				4.4																							
7	5.1				4.4				4.0																			
8	5.1				4.3				4.0				3.3				3.0											
9	5.0				4.3				4.0				3.2				2.9									2.5		
10	4.9				4.3				3.9				3.1				2.9									2.5		
12	4.7	3.3			4.1	3.1			3.8				3.0				2.8									2.4		
14	4.4	3.1			4.0	3.0			3.7	3.0			2.9	2.6			2.7									2.3		
16	4.2	3.0	2.4		3.8	2.9	2.3		3.6	2.8			2.8	2.6			2.6	2.4								2.3	2.1	
18	4.0	2.8	2.3	2.2	3.7	2.7	2.3		3.5	2.7	2.3		2.8	2.6	2.2		2.5	2.4								2.2	2.0	
20	3.7	2.7	2.3	2.1	3.5	2.6	2.2	2.1	3.4	2.6	2.2	2.1	2.7	2.5	2.2		2.5	2.3	2.1							2.1	2.0	
22	3.5	2.6	2.2	2.1	3.4	2.5	2.2	2.1	3.3	2.5	2.2	2.1	2.7	2.4	2.1	2.1	2.4	2.3	2.1	2.0						2.1	2.0	
24	3.2	2.5	2.2	2.1	3.2	2.5	2.1	2.1	3.0	2.5	2.1	2.1	2.6	2.4	2.1	2.1	2.4	2.3	2.1	2.0						2.0	2.0	
26	3.0	2.4	2.1	2.1	2.9	2.4	2.1	2.1	2.6	2.4	2.1	2.1	2.5	2.3	2.1	2.0	2.2	2.3	2.0	2.0						2.0	2.0	
28	2.7	2.3	2.1	2.1	2.4	2.3	2.1	2.1	2.5	2.3	2.1	2.1	2.2	2.2	2.0	2.0	1.9	2.2	2.0	2.0						1.7	2.0	
30	2.3	2.2	2.1	2.1	2.0	2.2	2.1	2.1	2.1	2.2	2.0	2.1	1.9	2.2	2.0	2.0	1.5	2.0	2.0	2.0						1.4	1.8	
32	1.9	2.2	2.0	2.1	1.7	2.1	2.0	2.1	1.8	2.1	2.0	2.1	1.5	1.9	2.0	2.0	1.2	1.6	1.9	2.0						1.1	1.5	
34	1.6	1.9	2.0	2.1	1.4	1.7	1.9	2.0	1.5	1.8	2.0	2.0	1.3	1.6	1.9	2.0	0.9	1.3	1.6	1.8						0.8	1.2	
36	1.3	1.6	1.7	1.7	1.1	1.4	1.6	1.7	1.3	1.5	1.8	1.8	1.0	1.3	1.6	1.7	0.7	1.0	1.3	1.5						1.0		
38	1.1	1.3	1.4	1.4	0.9	1.1	1.3	1.3	1.0	1.3	1.4	1.5	0.8	1.1	1.3	1.4		0.8	1.0	1.2						0.7		
40	0.9	1.0	1.1	1.0	0.7	0.9	1.0	1.0	0.8	1.0	1.2	1.2		0.8	1.0	1.1										0.8	0.9	
42	0.7	0.8	0.8			0.6	0.7	0.6		0.8	0.9	0.9		0.6	0.8	0.8												
44											0.7	0.6																
boom伸長率 (%)	I	92/0				46				92/0				46				92				100						
	II	46/92				92				92/92				92				92				100						
	III	46/46				46				46/92				92				92				100						
	IV	46/46				46				46/92				92				92				100						
	V	46/92				92				92/92				92				92				100						

t189-00100/00108/00116/00124

主寸法

LTM 1080NX

外観寸法

単位：mm

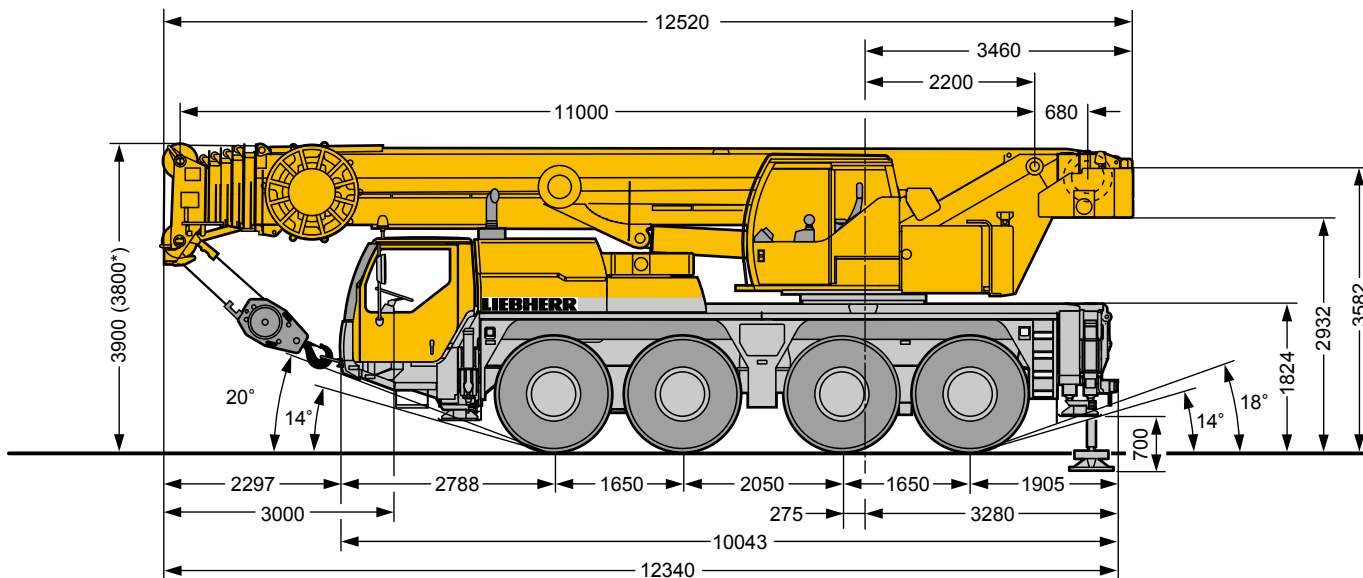

*サスペンションを100mm下げた状態

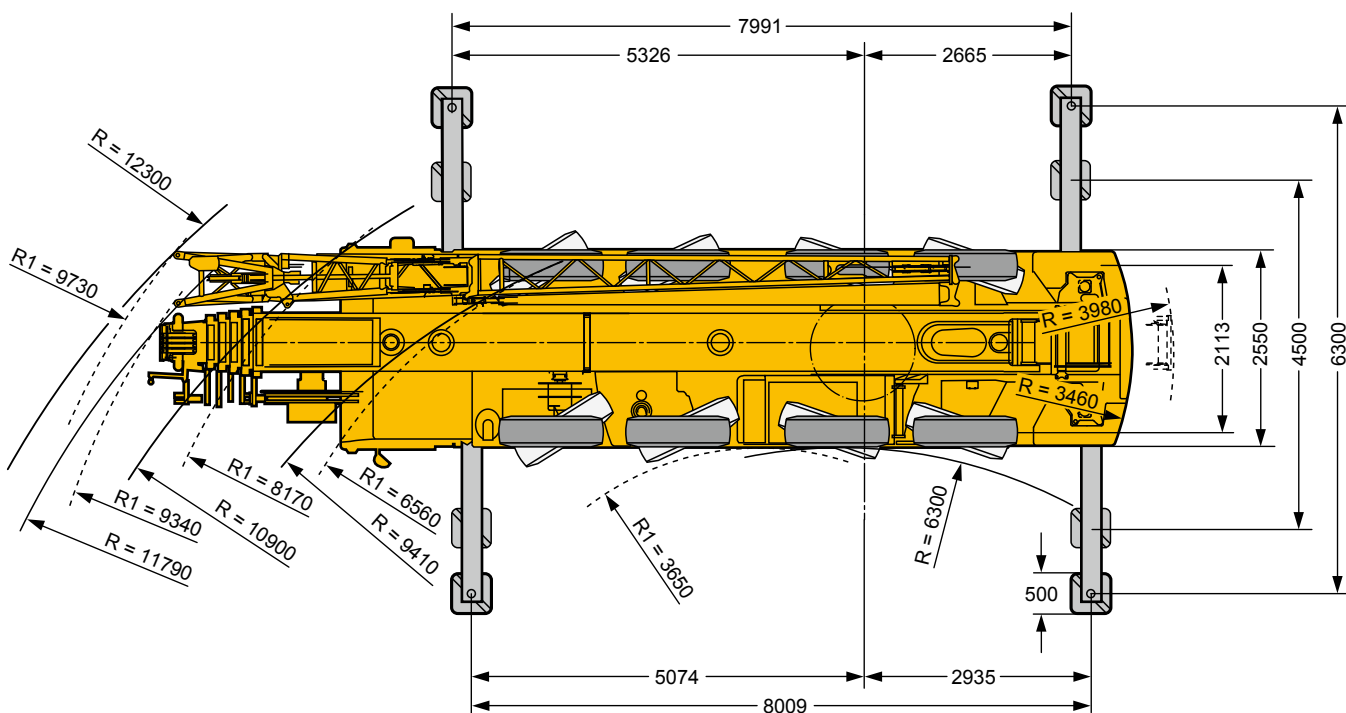

リープヘル・ジャパン株式会社

〒230-0053 横浜市鶴見区大黒町5番39号

TEL. 045-505-8687 (営業)

045-505-8689 (サービス)

FAX. 045-505-8683

なお、本仕様は予告なく変更することがあります。

TD 189.01.DEFIFR11.2009

2013.01.1000